

INSTALLATION INSTRUCTIONS

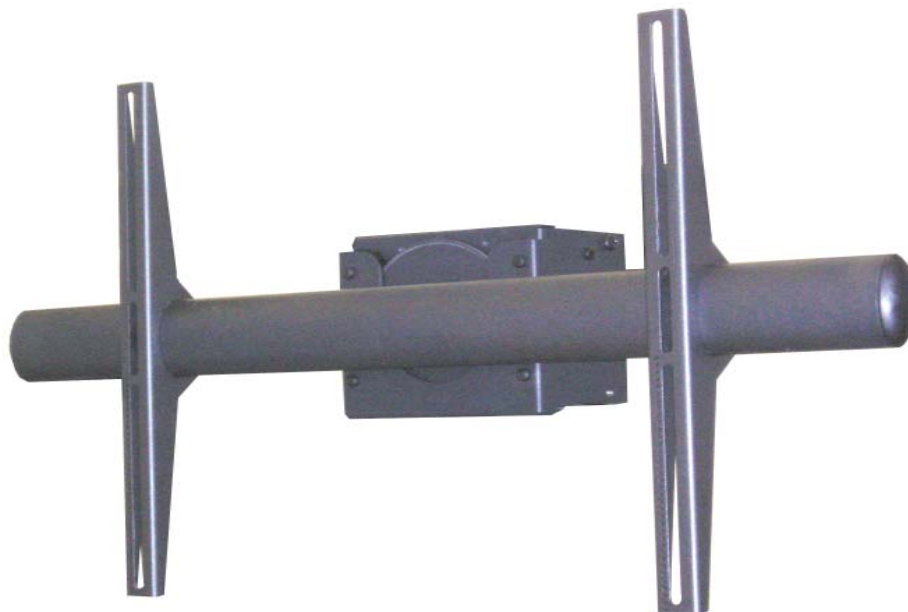

Rotary Series

Rotary Tilt Mount Model: RTM-L

NORTH AMERICA

3130 East Miraloma Avenue
Anaheim, CA 92806 USA
USA and Canada –
Phone: 800-368-9700
Fax: 800-832-4888

EUROPE

Swallow House,
Shilton Industrial Estate,
Shilton, Coventry, England CV79JY
Phone: +44 (0) 2476 614700
Fax: +44 (0) 2476 614710

AUSTRALIA, NEW ZEALAND, OCEANIA (DISTRIBUTOR)

P.O. Box 295
Mordialloc Victoria 3195
Australia
Phone: 039586 6330
www.premiermounts.com.au

Other Locations – Phone: (001)-714-632-7100; Fax: (001)-714-632-1044

©Premier Mounts 2008

9531-009-011-03



Table of Contents

Warning Statements 2

Parts List 3

Installation Tools 3

Thread Depth Indicator 6

Mount Installation 7

Universal Mounting Bracket Installation 8

Display Orientation 10

Tilt Positioning 10

Optional Configurations 11

Technical Specifications 11

Security Pack (Optional) 12

Warranty 13

Warning Statements



PRIOR TO THE INSTALLATION OF THIS PRODUCT, THE INSTALLATION INSTRUCTIONS SHOULD BE READ AND COMPLETELY UNDERSTOOD. THE INSTALLATION INSTRUCTIONS MUST BE READ TO PREVENT PERSONAL INJURY AND PROPERTY DAMAGE. KEEP THESE INSTALLATION INSTRUCTIONS IN AN EASILY ACCESSIBLE LOCATION FOR FUTURE REFERENCE.



PREMIER MOUNTS DOES NOT WARRANT AGAINST DAMAGE CAUSED BY THE USE OF ANY PREMIER MOUNTS PRODUCT FOR PURPOSES OTHER THAN THOSE FOR WHICH IT WAS DESIGNED OR DAMAGE CAUSED BY UNAUTHORIZED ATTACHMENTS OR MODIFICATIONS, AND IS NOT RESPONSIBLE FOR ANY DAMAGES, CLAIMS, DEMANDS, SUITS, ACTIONS OR CAUSES OF ACTION OF WHATEVER KIND RESULTING FROM, ARISING OUT OF OR IN ANY MANNER RELATING TO ANY SUCH USE, ATTACHMENTS OR MODIFICATIONS.



THE SURFACE MUST BE CAPABLE OF SUPPORTING AT LEAST FIVE TIMES THE WEIGHT OF THE DISPLAY. IF NOT, THE SURFACE STRUCTURE MUST BE REINFORCED. THE MAXIMUM WEIGHT THAT CAN BE USED WITH THIS PRODUCT IS 160LBS. PROPER INSTALLATION PROCEDURE BY A QUALIFIED SERVICE TECHNICIAN, AS OUTLINED IN THE INSTALLATION INSTRUCTIONS, MUST BE ADHERED TO. FAILURE TO DO SO COULD RESULT IN SERIOUS PERSONAL INJURY, OR EVEN DEATH.



SAFETY MEASURES MUST BE PRACTICED AT ALL TIMES DURING THE ASSEMBLY OF THIS PRODUCT. USE PROPER SAFETY GEAR AND TOOLS FOR THE ASSEMBLY PROCEDURE TO PREVENT PERSONAL INJURY.



At least two qualified people should perform the assembly procedure. Injury and/or damage can result from dropping or mishandling the display.



If mounting to studs, make sure that the mounting screws are anchored into the center of the studs. Use of an edge-to-edge stud finder is recommended.



This product is intended for indoor use only. Use of this product outdoors could lead to product failure and personal injury.



Do not install near sources of high heat. Do not install on a structure that is prone to vibration, movement or chance of impact



Contact Premier Mounts with any questions
 (800) 368-9700
 techsupport@mounts.com







Parts List

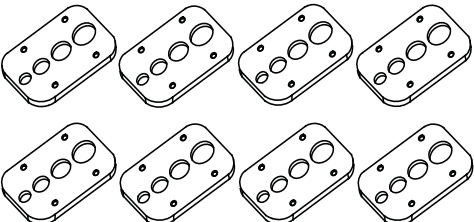
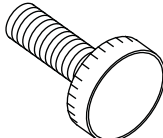

Note

This wall mount is shipped with all proper installation hardware and components. Make sure that none of these parts are missing and/or damaged before beginning installation. If there are parts missing and/or damaged, please stop the installation and contact Premier Mounts (800-368-9700).

 <p>Universal Mounting Brackets (Qty 2)</p>		 <p>Rotary Tilt Mount (Qty 1)</p>
 <p>Griplate™ (Qty 8)</p>	 <p>M6 Knurl Knob (Qty 1)</p>	 <p>Hand Crank (Qty 1)</p>

Installation Tools

Phillips Head Screw Driver
 Tape Measure
 5/32" Allen Wrench (Supplied)

Soft Material/ Blanket
 Thread Depth Indicator (Supplied)

Pencil
 Level (Supplied)

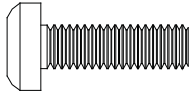

M4 x 16  (Qty 8)

M6 x 20  (Qty 8)

M4 x 25  (Qty 8)

M6 x 30  (Qty 8)

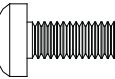
M5 x 12  (Qty 8)

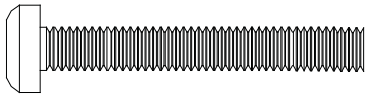
M6 x 45  (Qty 8)

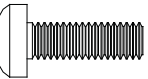
M5 x 16  (Qty 8)

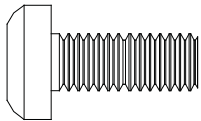
M8 x 20  (Qty 8)

M5 x 20  (Qty 8)

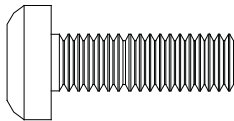
M8 x 25  (Qty 8)

M5 x 25  (Qty 8)

M5 x 50  (Qty 8)

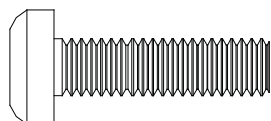
M8 x 30  (Qty 8)

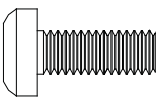
M6 x 16  (Qty 8)

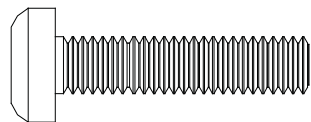
M8 x 35  (Qty 8)

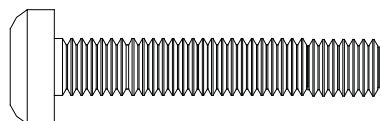
M8 x 45  (Qty 8)

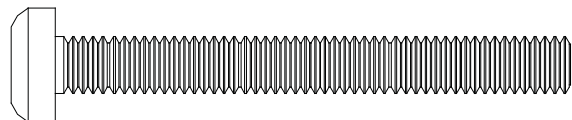
M8 x 70  (Qty 4)



Note

The nylon spacers may be stacked to achieve proper spacing.

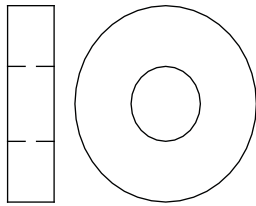

**1/4" Nylon spacers
(large)
(Qty 8)**

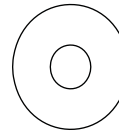
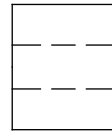

**9/16" Nylon spacers
(Qty 8)**

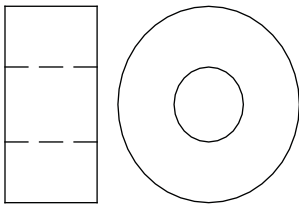

**1/2" Nylon spacers
(large)
(Qty 12)**

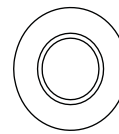
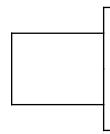

**Nylon sleeves
(Qty 8)**

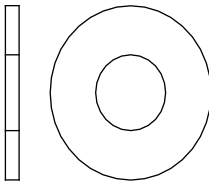

**5/16" Flat washers
(metal)
(Qty 8)**

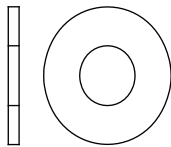

**1" Nylon Spacers
(Qty 8)**

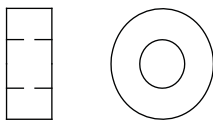

**1/4" Nylon spacers
(small)
(Qty 8)**



Thread Depth Indicator

1. Insert the thread depth indicator (supplied) through the thread inserts found on the back of the flat panel to make sure the inserts measure the same full depth and mark it (Figure 1).
2. Locate the correct diameter screw for the thread insert. Compare your marking to the screws (supplied).
3. If your selected screw is longer than the marking on the thread depth indicator, **DO NOT USE** this screw.
4. The screw length must not bypass the marking. Select another screw size (Figure 2 and 3), until you find one that comes closest to your mark without going past.

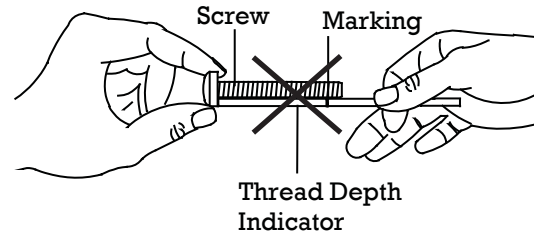
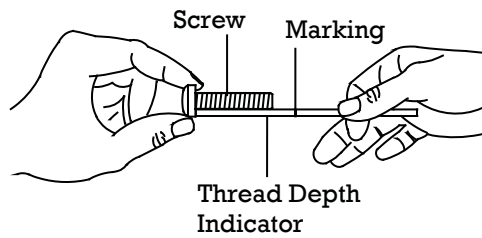
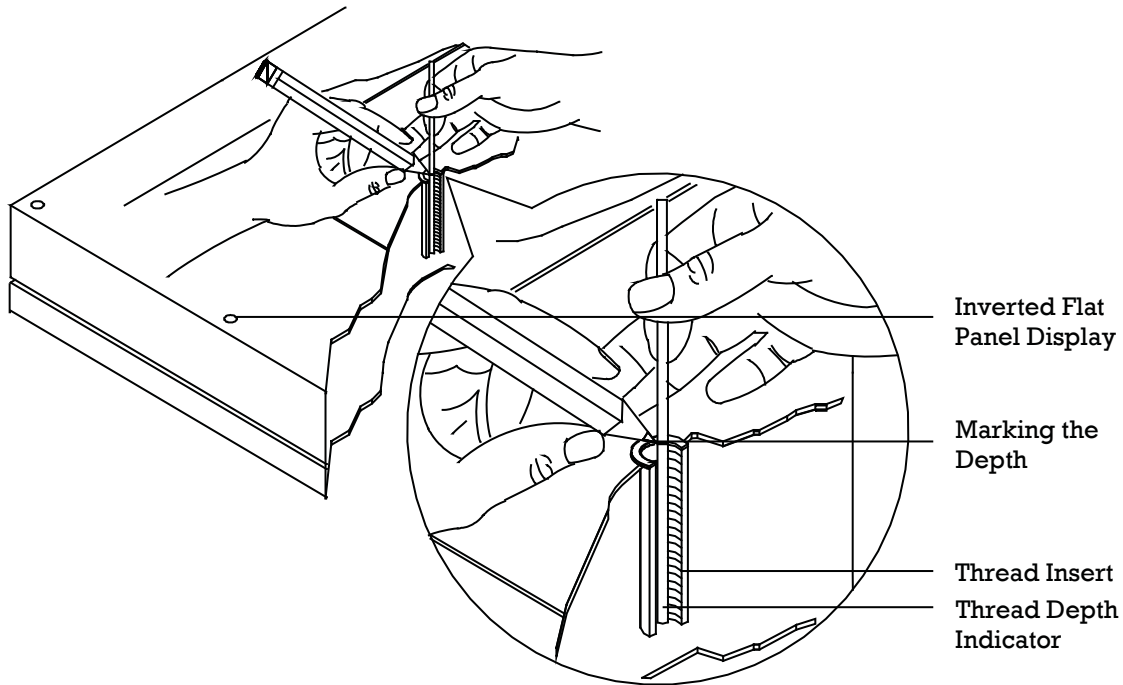



Mount Installation



Note

The installation instructions that are contained in this manual refer only to the RTM-L. The installation instructions for the various bases that are used with the RTM-L will be included with those products.



Note

Prior to installing the RTM-L, the mounting configuration must already be assembled (base, support poles, etc.).

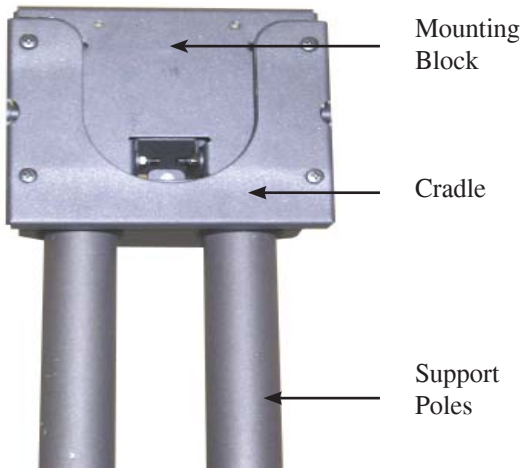

1. Slide the mounting block over and down the support poles.

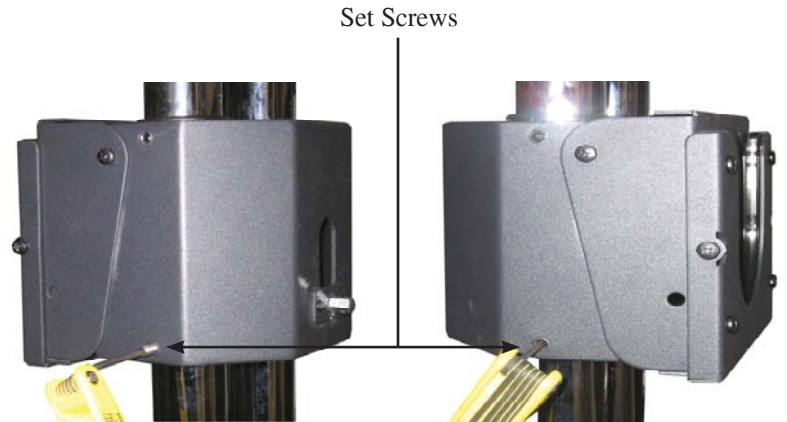

2. To secure the mounting block to the support poles, tighten the four set screws (located on each side of the mounting block), using the 5/32" Allen wrench (supplied).



Universal Mounting Bracket Assembly

1. Place the universal bracket bar and the universal brackets on a flat surface.
2. Slide the universal brackets onto the universal bracket bar (as shown below) with the set screws facing up. At this time, do not tighten the set screws that are located on the universal bracket.

**Note**

If you have an un-even mounting surface, or a recessed mounting point, place the appropriately sized nylon washer between the display and the universal mounting brackets (page 5).

3. Place the display on a soft, flat surface, face-down. Next, place the universal bracket assembly on the back of the display, with the universal brackets resting directly over the display mounting points.
4. Once the desired position has been determined, place the Griplate™ washers over each mounting point and secure them using the appropriate hardware (see Page 4 and 5).

**Note**

For the two upper mounting points, the Griplate™ flat side must be facing up. For the two lower mounting points, the Griplate™ flat side must be facing down.

5. At this time, center the universal bracket bar and tighten the set screws that are located on the universal brackets.

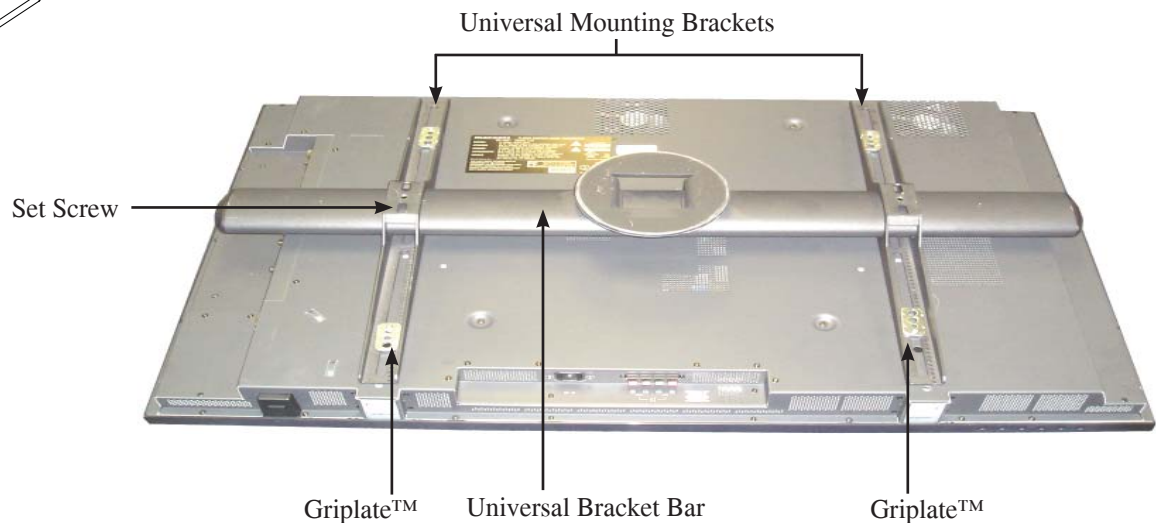
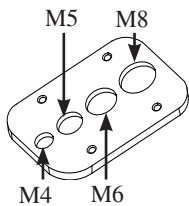
**WARNING**

IT WILL TAKE TWO PEOPLE TO COMPLETE THE NEXT INSTALLATION STEP.

**WARNING**

THE CONFIGURATION THAT THE UNIVERSAL MOUNTING BRACKETS ARE IN ABOVE MUST REMAIN THE SAME. ANY DEVIATION FROM THE LAYOUT ABOVE COULD AFFECT THE OPERATION OF THE MOUNT.

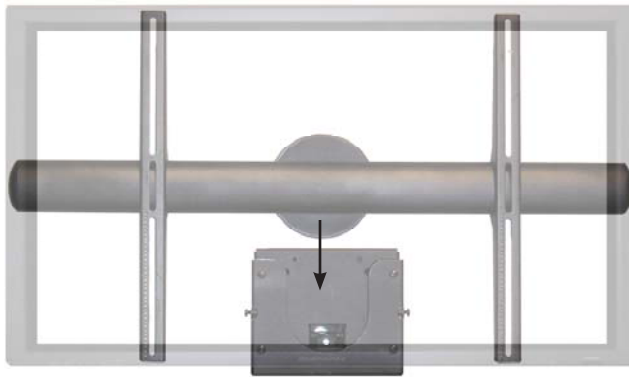

6. Lower the universal bracket bar and display into the cradle (as to the left).

**Note**

The circular portion of the universal bracket bar must rest inside the nylon sleeve. If seated improperly, the operation of the RTM-S will be hindered and the nylon sleeve will become damaged.



Nylon Sleeve

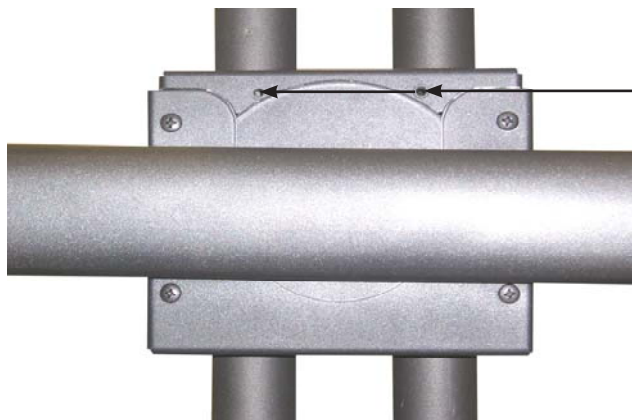

Knurl Knob Mounting Points (a knurl knob may be placed in either mounting hole)
M6 x 12mm Security Head and M6 Lock Washer Mounting Points (a security screw may be placed in either mounting hole).

7. Insert an M6 knurl knob into the knurl knob mounting point and tighten.
8. OPTIONAL - Insert a M6 x 12mm security screw and M6 lock washer into the mounting point and tighten using the M5 Allen wrench (supplied).
9. OPTIONAL - Tighten the two (2) Phillips head screws (located on the side of the mounting block) to prevent the mount from rotating.

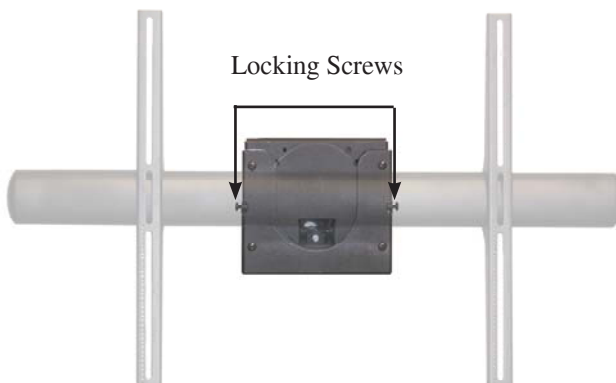



Display Orientation

The RTM-L will allow the user to adjust the display a full 360°.



WARNING

BEFORE ROTATING THE RTM-L, MAKE SURE THAT THE M6 KNURL KNOB IS SECURELY FASTENED TO THE RTM-L. ALSO, PLEASE MAKE SURE YOU ALLOW ENOUGH CABLE AND WIRE CLEARANCE FOR FULL ROTATION.

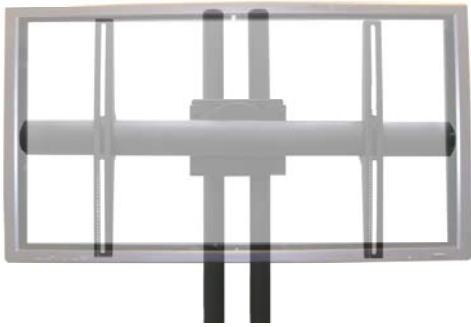

1. To adjust the RTM-L, rotate the display either clockwise or counter-clockwise.

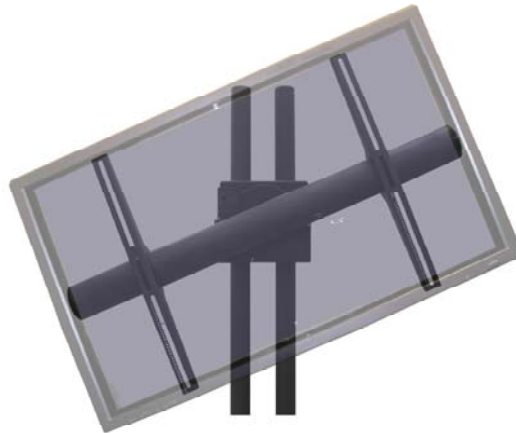

2. Tighten the two Phillips head locking screws.

Tilt Positioning



The RTM-L is shipped with the hand crank in the storage position. The hand crank must be removed in order for the RTM-L to be adjusted. After the adjustments have been made, return the hand crank to the storage position. If the hand crank is not returned to the storage position, it may cause damage to the unit or other equipment. Please return the hand crank to the storage position after operation.

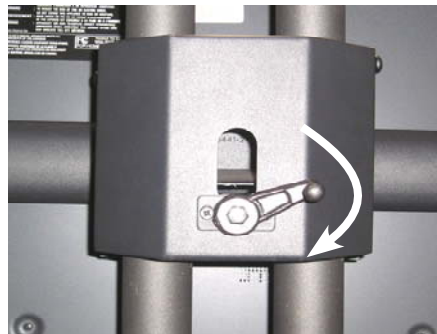

Rotate the crank handle to tilt the RTM-L:
Down - Clockwise
Up - Counter-Clockwise



The RTM-L has the ability to tilt 10° down.

The RTM-L has the ability to tilt 35° up

1. Once the position has been locked down, use an Allen wrench to take off the crank handle.
2. Once the crank handle has been removed, re-attach the crank handle, but in the opposite direction from what it was. This is the storage position for the handle.



Optional Configurations



PSD-TS



PSD-BW



PSD-EB

Technical Specifications

All measurements are in inches (mm).

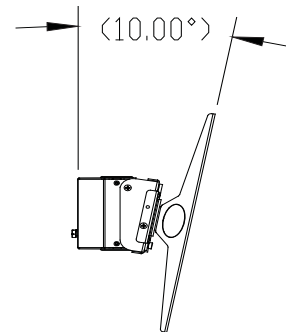
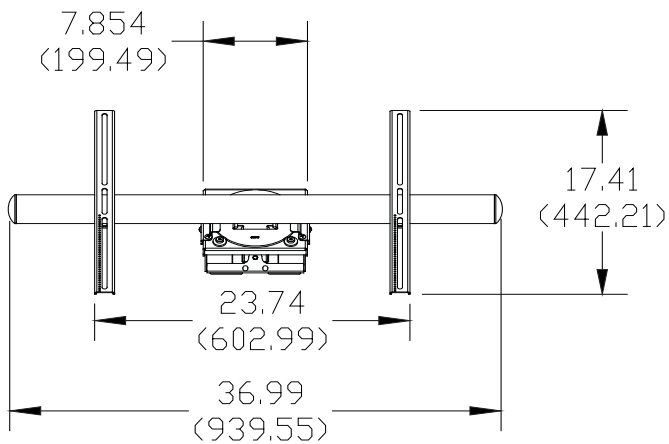
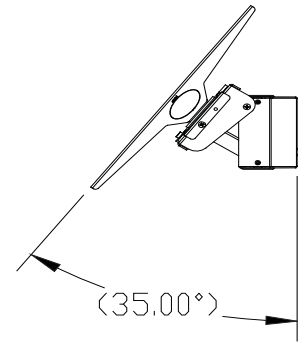
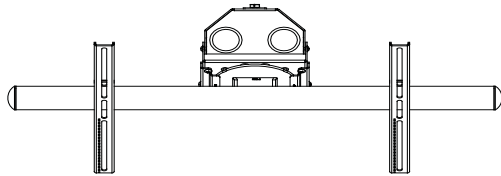



Lock-It™ Security Hardware Pack

The RTM-L is shipped with a safety knurl knob already installed. If the user decides to incorporate the optional security hardware, the following steps will show the user how to effectively remove the safety knurl knob and install the optional Lock-It™ hardware kit.



Note

The M6 security head screw will be installed after the RTM-L has been fully assembled. Installation of the M6 security head screw prior to completing assembly will not allow the RTM-L to function properly.



M6 x 12mm Security Head Screw (Qty 1) and Lock Washers (Qty 2)



Security Allen Wrench (Qty 1)

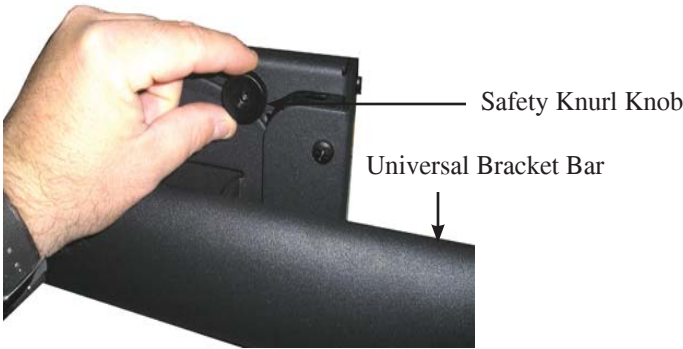

Step 1
Remove the RTM-L from the packaging and remove the existing safety knurl knob. Remove the universal bracket bar.

M6 Security Head Screw and Lock Washers

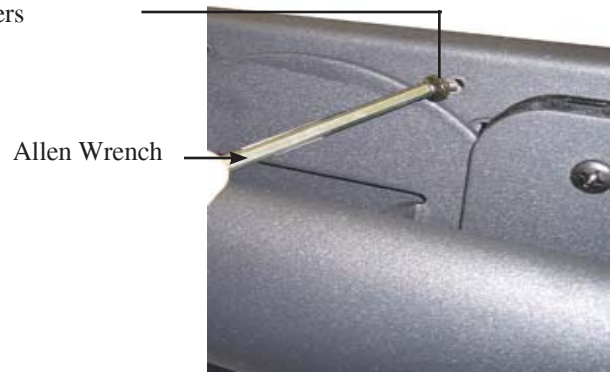

Step 2
Place the two lock washers onto the M6 x 12mm security head screw. Place the M6 x 12mm security head screw onto the security Allen wrench and insert into mounting point.



Step 3
Once inserted into the mounting point, fully tighten into place using the security Allen wrench.

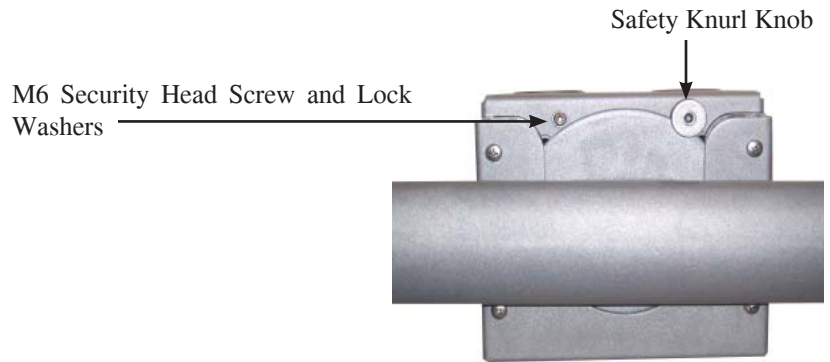

Step 4
Once the M6 security head screw has been installed, re-insert the safety knurl knob. Installation completed. This will prevent the display from being removed from the RTM-L assembly.



Warranty

PREMIER MOUNTS LIMITED LIFETIME WARRANTY

What and Who is Covered by this Limited Warranty and for How Long

Premier Mounts warrants this product to be free from defects in material and workmanship for the lifetime of the original owner of this product. The limited warranty is valid only for the original purchaser of the product.

What Premier Mounts Will Do

At the sole option of Premier Mounts, Premier Mounts will repair or replace any product or product part that is defective. If Premier Mounts chooses to replace a defective product or part, a replacement product or part will be shipped to you at no charge, but you must pay any labor costs.

What is Not Covered; Limitations

PREMIER MOUNTS DISCLAIMS ANY LIABILITY FOR DAMAGE TO MOUNTS, ADAPTERS, DISPLAYS, PROJECTORS, OTHER PROPERTY, OR PERSONAL INJURY RESULTING, IN WHOLE OR IN PART, FROM IMPROPER INSTALLATION, MODIFICATION, USE OR MISUSE OF ITS PRODUCTS.

PREMIER MOUNTS DISCLAIMS ALL OTHER WARRANTIES, EXPRESS OR IMPLIED, INCLUDING WARRANTIES OF MERCHANTABILITY AND FITNESS FOR A PARTICULAR PURPOSE. PREMIER MOUNTS IS NOT RESPONSIBLE FOR INCIDENTAL OR CONSEQUENTIAL DAMAGES, INCLUDING BUT NOT LIMITED TO, INABILITY TO USE ITS PRODUCTS OR LABOR COSTS FOR REMOVING AND REPLACING DEFECTIVE PRODUCTS OR PARTS. SOME STATES DO NOT ALLOW THE EXCLUSION OR LIMITATION OF INCIDENTAL OR CONSEQUENTIAL DAMAGES, SO THE ABOVE LIMITATION OR EXCLUSION MAY NOT APPLY TO YOU.

What Customers Must Do for Limited Warranty Service

If you discover a problem that you think may be covered by the warranty you **MUST REPORT** it in writing to the address below within thirty (30) days. Proof of purchase (an original sales receipt) from the original consumer purchaser must accompany all warranty claims. Warranty claims must also include a description of the problem, the purchaser's name, address, and telephone number. General inquiries can be addressed to Premier Mounts Customer Service at 1-800-368-9700. Warranty claims will not be accepted over the phone or by fax.

Premier Mounts
Attn: Warranty Claim
3130 E. Miraloma Avenue
Anaheim, CA 92806

How State Law Applies

THIS WARRANTY GIVES YOU SPECIFIC LEGAL RIGHTS, AND YOU MAY ALSO HAVE OTHER RIGHTS WHICH VARY FROM STATE TO STATE.